

Article number: 40600701932435
 Description: Helical gearbox
 C702F-19,3-P90B5

Measures

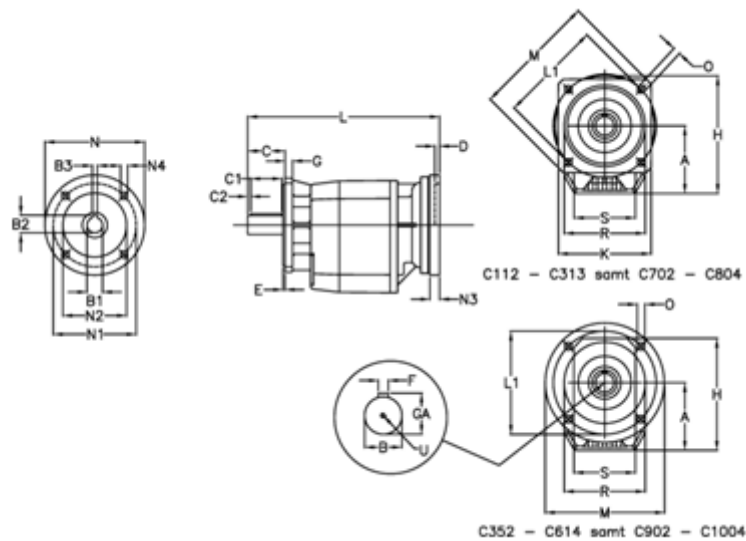

A = 208.0	D = 4.0	L1 = 300	R = 262
B = 60	E = 5	M = 350	S = 250
B1 = 24	F = 18	N = 200	U = M20x42
B2 = 27.3	G = 17	N1 = 165	
B3 = 8	GA = 64.0	N2 = 130	
C = 120	H = 358.0	N3 = 0	
C1 = 90	K = 300	N4 = M10x12	
C2 = 15	L = 473.0	O = 18.0	